



**f490w**

**Car Camcorder  
User Manual**

## Index

	<i>About This Guide</i> .....	3
	<i>Regulatory Notices</i> .....	3
	<i>Prohibition of Co-location</i> .....	3
	<i>WEEE Notice</i> .....	3
	<i>CE Regulatory Notice</i> .....	4
	<i>Notes on Installation</i> .....	4
	<i>Caution</i> .....	5
1	Introduction.....	7
	1.1 <i>Features</i> .....	7
	1.2 <i>Package Contents</i> .....	7
	1.3 <i>Product Overview</i> .....	8
2	Get Start .....	9
	2.1 <i>Storage Media</i> .....	9
	2.1.1 <i>Insert the Memory Card</i> .....	9
	2.1.2 <i>Remove the Memory Card</i> .....	9
	2.2 <i>Install</i> .....	10
	2.2.1 <i>Mount the Camcorder to Windshield</i> ....	10
	2.2.2 <i>Adjust the Camcorder</i> .....	11
	2.3 <i>Connecting to Power</i> .....	12
	2.4 <i>LED Indicator</i> .....	12
	2.5 <i>Power on/off and Reset</i> .....	13
	2.5.1 <i>Auto Power on/off</i> .....	13
	2.5.2 <i>Reset</i> .....	13
3	Setting Go Moto Plus App .....	14

3.1	<i>Download</i> .....	14
3.2	<i>Wi-Fi Connection</i> .....	15
3.3	<i>Use Go Moto Plus App</i> .....	16
3.4	<i>Set Up and Operate Camcorder</i> .....	17
3.4.1	Main Screen.....	18
3.4.2	Playback, Delete, Download .....	20
3.4.3	Camera Setting .....	23
3.4.4	Album.....	25
4	<i>Use the Camcorder</i> .....	28
4.1	<i>Initial Setting</i> .....	28
4.2	<i>Recording</i> .....	28
4.3	<i>Emergency Recording</i> .....	28
4.4	<i>Picture in Video</i> .....	29
4.5	<i>Parking Mode</i> .....	30
5	<i>OTA Firmware Upgrade</i> .....	31
6	<i>Specification</i> .....	35

## About This Guide

The content in this document is for information purpose and is subject to change without prior notice. We have made every effort to ensure that this User Guide is accurate and complete. However, no liability is assumed for any errors or omissions that may have occurred.

The manufacturer reserves the right to change the technical specifications without prior notice.

## Regulatory Notices

This document provides country- and region-specific non-wireless and wireless regulatory notices and compliance information for your product. Some of these notices may not apply to your product.

## Prohibition of Co-location

This device and its antenna(s) must not be co-located or operated in conjunction with any other antenna or transmitter.

## WEEE Notice

### Disposal of Waste Electrical and Electronic Equipment and/or Battery by users in private households in the European Union



WEEE



Battery

This symbol on the product or on the packaging indicates that this cannot be disposed of as a household waste. You must dispose of your waste equipment and/or battery by handing it over to the applicable take-back scheme for the recycling of electrical and electronic equipment and/or battery. For more information about recycling of this equipment and/or battery, please contact your city office, the shop where you purchased the equipment or your household waste disposal service. The recycling of materials will help to conserve natural resources and ensure that it is recycled in a manner that protects human health and environment.

## **CE Regulatory Notice**

The product herewith complies with the requirements of the IEC 62368-1:2018, the EMC Directive 2014/30/EU, and the RoHS Directive 2011/65/EU.

EU Health Protection: This equipment should be installed and operated with minimum distance 20cm between the radiator & your body.

Disposal of a battery into fire or a hot oven, or mechanically crushing or cutting of a battery, that can result in an explosion.

Leaving a battery in an extremely high temperature surrounding environment that can result in an explosion or the leakage of flammable liquid or gas.

## **Notes on Installation**

1. Please measure the front windshield viewing area, make sure not to block driver's front view, install the camcorder below the rearview mirror (the central, higher right position of the front windshield). And we recommend that the sky and the land occupied by the screen 50%, fix the car holder and then adjust the camcorder so that the lane is aligned with the screen.
2. Make sure that the lens is within the wiping range of the windscreen wiper to ensure a clear view even when it rains.
3. Do not touch the lens with your fingers. Finger grease may be left on the lens and will result in unclear videos or pictures. Clean the lens on a regular basis.
4. Do not install the camcorder on a tinted window. Doing so may damage the tint film.
5. Make sure that the installation position is not hindered by the tinted window.
6. This product is suitable for light windshield or light color heat-resistant film windows, it will affect video quality if install it on the dark windows or dark heat-resistant film windows.
7. Use the products of the attached power charger only, please do not use other brand power charger, in order to avoid equipment burn.

## Caution

- ❖ Due to local laws and vehicles safety considerations, do not operate the camcorder while driving.
- ❖ Set up date and time accurately before you use this camcorder.
- ❖ The firmware function in the camcorder is for reference only, drivers are advised to exercise discretion based on actual road conditions.
- ❖ This product is used only for non-commercial use, within the maximum limits permitted by applicable law. We do not take any responsibilities for the loss of use of the product.
- ❖ Wi-Fi Signals are unable to pass through the building. The max limit of signal transmission is 5m.
- ❖ Wi-Fi Operation Channel: Ch1~Ch13
- ❖ The product employs wireless data communication which may interfere, or be interfered by, a near-by camcorder.
- ❖ Never use this camcorder in the vicinity of a microwave oven or at places where there is radio interference.
- ❖ Radio wave reception may be worsened in specific environments.
- ❖ Please be advised that if another camcorder is also using the same 2.4GHz band as this product, the processing speed of both camcorders may slow down.
- ❖ This camcorder gets warm when in use; this is normal.
- ❖ Improper use or operation of the product may result in damage of the product or its accessories and void the warranty.
- ❖ The radio frequency (RF) generated by this RF electronic camcorder may cause adverse effects on the operation of other electronic camcorders and result in malfunctioning. Wireless transmitters and circuitry may also interfere with other electronic camcorders. Therefore, do observe the following precautions:
  - Aircraft: Never use a radio transmitter when you are in an airplane. Please switch off the Wi-Fi function of the camcorder.
  - Vehicle: The radio frequency transmitted by this camcorder may affect the electronic system in a motorized vehicle. Please

consult the manufacturer or dealer of your vehicle on the possible effect.

- **Pacemaker:** In order to prevent any potential interference to a pacemaker, anyone who uses a pacemaker should be advised, that, when using this camcorder, a minimum distance of 15cm (6 inch) should be kept between the camcorder and the pacemaker; and never put this camcorder in a chest pocket. In case of any doubt of interference, switch off the camcorder immediately.
- **Medical Camcorder:** If you use a personal medical camcorder, consult the camcorder manufacturer or your physician to confirm if your camcorder is sufficiently shielded from the RF transmission of this camcorder.
- **Medical Facilities:** Hospitals and medical institutes may use facilities that are sensitive to an external RF energy. Observe such instructions when the medical care personnel or any posted sign requests you to switch off any camcorder that may interfere the radio frequency.
- **Explosion sites or any location with a posted sign:** In order to prevent interfering with an explosion activity, observe all the signage and instructions in the Explosion Area or in a zone with a "Switch Off 2-way Radios" sign by switching off camcorders that may interfere with the radio frequency.

- ❖ HP Inc. is NOT responsible for the loss of any data/content during operation.

**Before you start using the product, it is assumed that you agree to the above statement.**

# 1 Introduction



Thank you for purchasing this advanced Car Camcorder. This product is specifically designed for real time video recording when driving.

## 1.1 Features

- Super HD 1296p (2304x1296)
- Built-in Wi-Fi, preview and playback the files from app
- Parking Mode
- Wide angle lens
- Collision Detection, when a collision is detected, the camcorder will automatically trigger the emergency recording

## 1.2 Package Contents

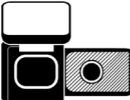
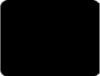
The package contains the following items. In case there is any missing or damaged item, contact your dealer immediately.

Car Camcorder	Electro-static Sticker	User Manual	Car Adapter
 An illustration of the car camcorder, showing the main unit with a lens and a separate lens cap.	 A solid black rectangular sticker.	 An icon of a document with a folded corner and three horizontal lines representing text.	 An illustration of a car adapter, featuring a USB-A connector on one end and a car cigarette lighter plug on the other.



## 1.3 Product Overview

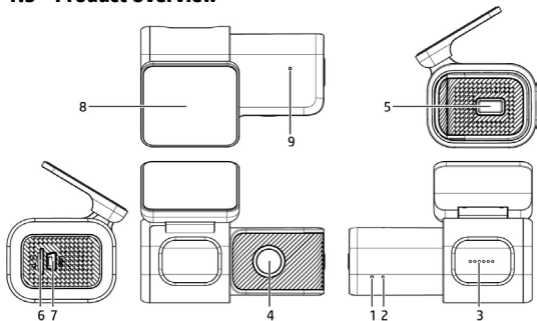

No	Item
1	LED Indicator
2	Microphone
3	Speaker
4	Wide angle lens
5	Short press: Emergency Long press: Power off

No	Item
6	microSD card slot
7	Power connector
8	Bracket socket
9	Reset hole

## 2 Get Start

### 2.1 Storage Media

#### 2.1.1 Insert the Memory Card

Insert memory card with the pins facing forward, see the picture as below:

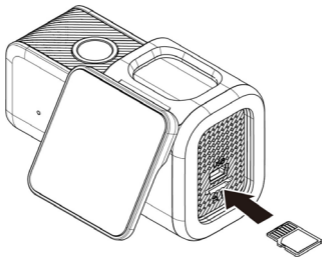

#### 2.1.2 Remove the Memory Card

If the camcorder is power on, please power off first and wait for the procedure of switching off the camcorder completed before removing the memory card.

**Note:**

1. Do not remove or insert the memory card when the camcorder is turned on. This may damage the memory card.
2. Support microSD class 10 and memory storage 16GB or above (support up to 128GB).
3. Please use this car camcorder to format the microSD card before the initial use.
4. Periodically format the microSD card (recommended period: once a month).

## 2.2 Install

### 2.2.1 Mount the Camcorder to Windshield

1. Put the electrostatic sticker onto the suggested area on the windshield. Before putting the sticker, please wipe and clean the windshield. During the installation, please make sure the bubbles in between the sticker and the window are all gone.

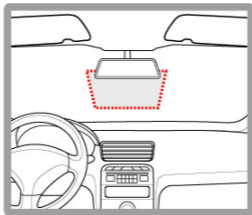

2. Peel off the protective plastic sheet from the adhesive pad.

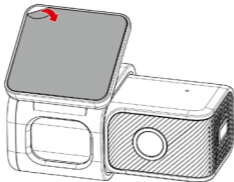

3. Place and press the bracket firmly onto the electrostatic sticker on the windshield window. Make sure the base is securely locked in place.

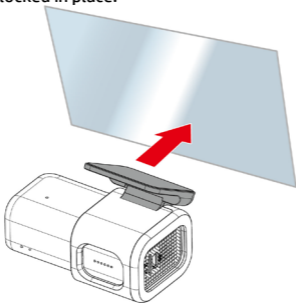

### 2.2.2 Adjust the Camcorder

1. Adjust the view angle.

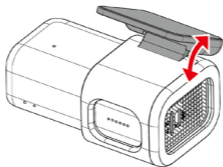

2. Make sure the camcorder is securely locked in place.

## 2.3 Connecting to Power

Use only the attached power adapter to activate the camcorder.

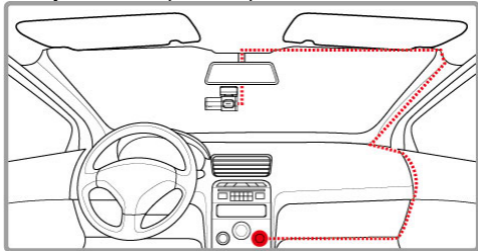

1. Connect one end of power connector to mini USB port of the camcorder. USB port input DC5V/1A.
2. Plug the other end of car adapter to the cigarette lighter socket of your vehicle. Once the vehicle engine is started, the camcorder automatically turns on. Car adapter input DC 12/24V.

## 2.4 LED Indicator

Status	LED Indicator
Power on, standby	Red, solid
Recording	Red, slow flashing
Emergency recording	Red, rapid flashing

## **2.5 Power on/off and Reset**

### **2.5.1 Auto Power on/off**

Once start the car engine, the camcorder will automatically power on and start recording.

Once the car engine shuts down, the camcorder automatically saves the recording and turns off the power.

### **2.5.2 Reset**

Use a pin to pin the reset hole.

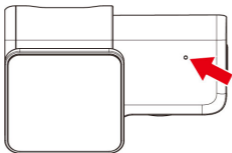

## 3 Setting Go Moto Plus App

### 3.1 Download

The camcorder allows you to connect to the smart phone via the app. When using for the first time, install the [Go Moto Plus] app for your smart phone.

Scan below QR code or download **Go Moto Plus** app from Google Play or App Store.



iOS/Android

**APP layout and features may be changed subject to different software versions. Please refer to Google Play or APP Store for update.**

## 3.2 Wi-Fi Connection

1. Starts the engine, and the camcorder will auto power on and record.
2. Using the Wi-Fi function of your smart phone and search for camcorder's ID "hp\_f490w\_xx\_xxxx" (last 4 digits are system random number). Enter default password **12345678**.

**Note:**

1. Wi-Fi connection in between with the smart phone and camcorder must within 5 meters open space.
2. The language of the Go Moto Plus app will be consistent with your smart phone, beyond the language options, the app will be activated with default language.
3. Supports OS: Android 9.0 or higher, iOS 13 or higher, Harmony 2 or higher.



### 3.3 Use Go Moto Plus App

Tap [Go Moto Plus] icon  to launch the app. The main screen will pop up. Follow the below instruction to operate this application.



### 3.4 Set Up and Operate Camcorder



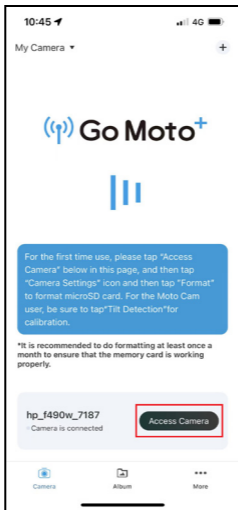

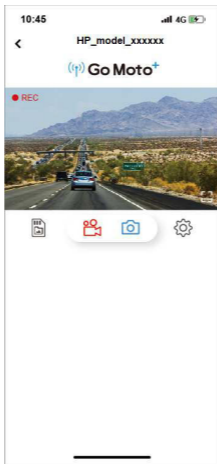

Tap “Access Camera” to enter main screen for set up and operate camcorder.



### 3.4.1 Main Screen



icon	Description
 <p>The icon area contains the 'Go Moto+' logo with a blue signal icon to its left. Below the logo is an orange rounded rectangle containing a white exclamation mark icon and the text 'Periodically format the microSD card.'</p>	<p>Go Moto Plus logo / SD card message</p>

	<p>Preview screen</p>
	<p>Full screen display</p>
	<p>Start/Stop recording</p>
	<p>Take photo</p>
	<p>Camera File (check the files in microSD)</p>
	<p>Camera Setting</p>
<p>Emergency video files will be overwritten by loop recording Backup important files</p> 	<p>To remind the emergency files in the microSD card is about to be full and going to over write the oldest files. Backup the files and clear up the emergency folder, and this message will be gone.</p>

**Note:**

The camcorder will synchronize date/time with smart phone once open the app.

### 3.4.2 Playback, Delete, Download

You can use this feature to playback or delete the file saved in camcorder, or to download the file from camcorder to your smart phone.







1. Tap the icon [Camera File], the camcorder will stop recording.
2. The files saved in the camcorder will be displayed on your smart phone. There are Loop, Snapshot and Locked three folders. Tap the image and it will start to playback.

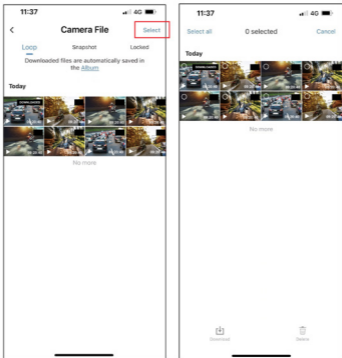

3. Tap the right top corner “Select” and pick up the files that you want to delete or download, and tap the icon in the screen bottom to execute.



icon	Description
	Download the file to “Local Album”. The downloaded file can be playback without connecting with the camcorder.

	<p>Video Screenshot.</p>
	<p>Delete the file in microSD card.</p>
	<p>Downloaded file will show “Downloaded” in thumbnail image.</p>

**Note:**

1. If you find the video playback without audio, please check if you turn on Voice Record on the Setting. If you do turn it on, it means the smart phone itself doesn't support the video decoding. It's not the problem of the file. We recommend you to install a free app software such as VLC to playback the file.
2. Deleted files cannot be recovered. Ensure the files have been backed-up before deletion.
3. More files to be read or downloaded, you are recommended to take out microSD card from camcorder and use computer.

### 3.4.3 Camera Setting

You can use this feature to set up most of your camcorder options.

1. Tap icon  [Camera Setting].
2. Refer to the below table for details of menu items and available menu options.

<b>Menu Option</b>	<b>Description</b>	<b>Available options</b>
Camera Volume Setting	Setting volume	1~10
Record Interval	Save respective video files in a length of the selected duration.	1 min / 2 min / 3 min
Collision Detection	Set up sensitivity level of collision detection.	Off / High / Mid / Low
Format	To format the memory card, all the files in the camcorder will be deleted.	Yes / Cancel
Resolution	Set up resolution of recording video	1296p (30fps) 1080p (30fps)
Anti-flicker	Domestic power supply varies by area. It is recommended that you should check the “Table of voltage and frequency of different countries” for the correct setting.	50Hz / 60Hz



Parking Mode	If one of parking mode is activated, the camcorder will enter parking mode 10 seconds after disconnect the external power. *Require to install ACC cable.	12H / 24H / Off
Wi-Fi Password	To set up Wi-Fi password	
Default	Return to factory default setting.	Yes / Cancel
Firmware Version	Indicates the current camcorder's firmware version.	

### 3.4.4 Album



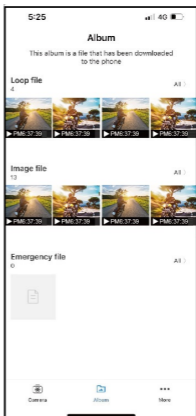

You can use this feature to playback or delete the file that you download in your smart phone. The files in the Album can be reviewed without connecting with camcorder.

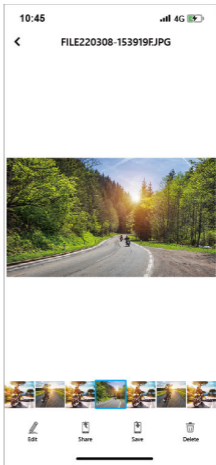
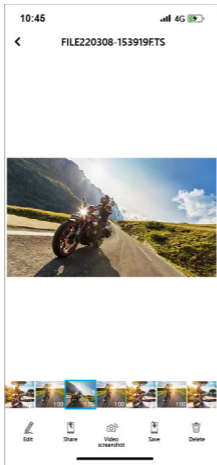
1. Tap icon  [Album]. (It will stop recording if the camcorder is connected.)
2. Tap the file that you want to playback, delete or edit.





Icon	Description
	Edit video or snapshot.

	Share the file to social media.
	Video Screenshot. The file will be saved in "Album".
	Save the file to smart phone's album. When the file saving is done, screen message will show "Save to smartphone's album successfully", and the smart phone's album will create a new folder named "Go Moto Plus".
	Delete the file in the App's Album. The file in the camcorder still exists.

**Note:**

1. Deleted files cannot be recovered. Ensure the files have been back-up before deletion.
2. If you find the downloaded files unable to playback or without audio, which means the smart phone itself does not support the video decoding. It's not the problem of the file. We recommend you to install one free App software such as VLC to playback the file.

## 4 Use the Camcorder

### 4.1 Initial Setting

Before use the camcorder, use smart phone's Wi-Fi to connect with the camcorder and open Go Moto Plus  app to synchronize date/time.

### 4.2 Recording

Once start the car engine, the camcorder will automatically power on and start recording.

Recording will automatically stop when the engine is switched off.

Note:

1. Some vehicle power supply would not turn on / off automatically with the car engine start, if the camcorder cannot automatically power on/off with the car engine, please manually connect the power supply with the vehicle power, and then power on, or manually power off the camcorder and then release the connector with the car power supply.
2. It can be configured to save a video file for every 1, 2 or 3 minutes of recording.
3. All the videos and photos are saved in the memory card, if memory card is full, loop recording will generally overwrite the oldest video file.

### 4.3 Emergency Recording

1. If the *Collision Detection* function is enabled and a collision is detected, the camcorder will automatically trigger the emergency recording. The emergency file is created as a new file and save in Emergency folder, which will be protected to avoid being overwritten by normal loop recording. The

emergency recording's file length is same as the Recording Interval Setting. When the emergency recording length reaches the setting, the system will return to the normal recording mode.



2. To manually lock the file as emergency, press the button to start emergency recording.

Note:

The emergency video folder will occupy 20% of available memory card capacity. When the emergency video folder is full, the oldest emergency file will be automatically deleted by the newest emergency file.

#### 4.4 Picture in Video

You can also use this camcorder to take snapshots of the current scene.

1. Open Go Moto Plus  app.
2. Tap  icon.
3. "Picture Success" will be heard and which means snapshot is done.



Note:

1. The screen shots image resolution quality is 1920x1080p.
2. The picture resolution is limited by the speed of the target object and changes in ambient lighting. The photograph function is better used for taking still pictures in accident scenes or when the car is stopped to wait for a traffic light.

## 4.5 Parking Mode

To monitor the vehicle when it is parked, you can activate **Parking Mode**.

**Before you activate Parking Mode, it is required to install ACC cable through professional car service shop.**

1. Open Go Moto Plus  app.
2. Tap  icon, “Stop Recording” will be heard, and you will enter Menu Setting.
3. Set up Parking Mode 12 hours or 24 hours. After setting, return to preview page.
4. When car’s engine is shut down, the camcorder will announce “Start Timelapse Recording” and then enter parking mode. When the collision is detected, the emergency recording will be triggered.
5. When car’s engine again starts, the camcorder will disable parking mode and resume normal loop recording.

Note:

1. ACC cable is not included in the package. Please ask for more information from your distributor.
2. “Parking Mode” option will appear in Menu Setting only when ACC cable is installed.
3. The video file taken in this mode is same as normal loop recording mode. It will be saved in the “Video” folder. And the emergency file will be saved in the “Emergency” folder. The file size is according to Record Interval setting.
4. Parking Mode is taking videos in Timelapse format. The camcorder is continuously recording by one second one frame. For example, 30 minutes recording will be saved in one minute.

## 5 OTA Firmware Upgrade

Connect Wi-Fi of the camcorder and smart phone, open the app. If there is a new firmware published, the screen will show notification as below.

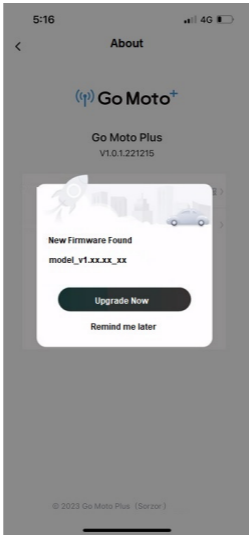



Follow the app instruction,

1. Tap “Upgrade Now”<sup>note1</sup> to download the new firmware to smart phone<sup>note2</sup>. (Figure1)
2. When download is completed, screen will show “Upgrade file has been downloaded”. Make sure smart phone Wi-Fi is connected with camcorder, then, tap the “Upgrade Now” on the right bottom corner. Then, the new firmware will be sent from smart phone to the camcorder. (Figure2)

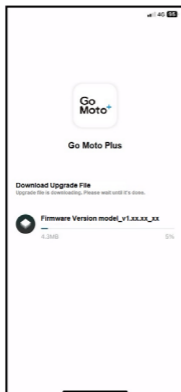

Figure1

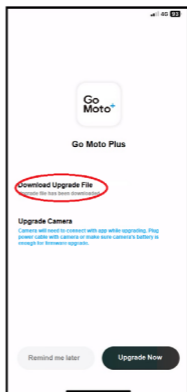
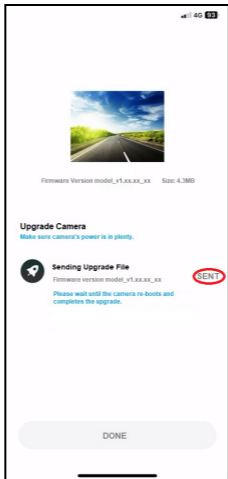

Figure2

3. When the file is dispatched successfully, screen will show “SENT”. The camcorder will then re-boot and automatically upgrade the firmware. After firmware is upgraded, the camcorder will power off.



4. Manually power on the camcorder, and it will work in the latest firmware.

**Note:**

1. If tap “Remind me later”, the app notification will pop up every time when the camcorder is connected.
2. When the smart phone’s Wi-Fi is occupied by the camcorder, iOS system will auto switch to cellular data, and the network is still useable; but, Android system won’t. Please attention the following notices to upgrade new firmware.
  - (1) iPhone User: Because the smart phone’s Wi-Fi is connected with the camcorder, iPhone will use cellular data to download the new firmware. If you don’t want to use cellular data to download, cut off the smart phone’s Wi-Fi connection with camcorder firstly, then connect with local area network. Then, open the app once again and tap “Upgrade Now” to download new firmware to smart phone.
  - (2) Android User: Because the smart phone’s Wi-Fi is connected with the camcorder, Android phone has no network to download the file. Please cut off smart phone’s Wi-Fi connection with the camcorder firstly, and connect with local area network. Or, turn off the Wi-Fi, and use cellular data. Then, open the app once again and tap “Upgrade Now” to download new firmware to smart phone.

## 6 Specification

Item	Description
Image Sensor	2MP CMOS sensor
Effective Pixels	1920 (H) x 1080 (V)
Storage Media	Supports MicroSD 16GB and higher, and class 10 and higher.
Lens	Wide angle fixed focus lens
Focus Range	1.5m~infinity
Video	Resolution: 1296P/ 30 fps、1080P/ 30 fps
	Format: TS
Picture	Resolution: according to video resolution setting
	Format: JPG
G-Sensor	3 Axis G-force sensor
ISO	Auto
White Balance	Auto
Microphone	Built-in
Speaker	Built-in
Interface	Mini USB

<b>Item</b>	<b>Description</b>
Operation Temperature	0° ~ 60° C
Operation Humidity	20 ~ 70% RH
Storage Temperature	-20° ~ 70° C
Dimension	79 x 29.7 x 41.6 mm (Bracket is not included)
Weight	approximate 52g

**Built-in IEEE 802.11b/g/n(HT20) Wi-Fi Chip: SSW101B**

Wi-Fi Band	2412~2484MHz
Wi-Fi Frequency	Ch1~Ch13