



f450x

**Car Camcorder
User Manual**

Contents

About this Guide	3
Regulatory notices	3
Prohibition of co-location	3
WEEE Notice	3
CE Regulatory Notice	3
Notes on Installation	4
Caution	4
1 Introduction.....	7
1.1 Features.....	7
1.2 Package Contents.....	7
1.3 Product Overview.....	8
2 Getting Started	9
2.1 Storage Media.....	9
2.1.1 Insert the Memory Card	9
2.1.2 Remove the Memory Card.....	9
2.2 Installing in Vehicles	10
2.3 Connecting to Power.....	12
2.4 LED Indicator	12
2.5 Powering the Camcorder On / Off	13
2.5.1 Auto Power On/Off.....	13
2.5.2 Manual Power On/Off	13
2.5.3 Reset.....	13
2.6 Initial Settings	14
2.6.1 Set Time Zone	14
2.6.2 Set the Date / Time	14
3 Using the Car Camcorder	15
3.1 Automatic Record.....	15
3.1.1 The Recording Screen.....	15
3.1.2 Emergency Recording	18
3.2 Add Speed Point.....	18
3.3 Picture in Video	19
3.4 Driving Safety	20
3.4.1 Speed Cam Alert	20
3.4.2 Speed Limit Alert	21
3.4.3 Driver Fatigue Alert.....	22
3.4.4 LDWS.....	22
3.4.5 FCWS.....	24

3.4.6	Headlight Warning	25
3.5	Parking Mode.....	26
3.5.1	Park Recording	26
3.5.2	Collision Detection	27
3.5.3	Timelapse	27
3.6	Collision Detection	28
3.7	HUD	28
3.8	Playback Videos and Photos	29
3.9	Deleting Files	30
4	Setting Go Moto Plus App	31
5	Using the Go Moto Plus App	34
5.1	Main Screen	35
5.2	Playback, delete and download.....	37
5.3	Local Album.....	39
5.3.1	Edit Video or Picture.....	41
5.4	Camera Setting	42
6	Adjusting the Settings	43
6.1	Using the Menu	43
6.2	Menu Items.....	43
7	Specifications	47

About this Guide

The content in this document is for information purpose and is subject to change without prior notice. We have made every effort to ensure that this User Guide is accurate and complete.

However, no liability is assumed for any errors or omissions that may have occurred.

The manufacturer reserves the right to change the technical specifications without prior notice.

Regulatory notices

This document provides country- and region-specific non-wireless and wireless regulatory notices and compliance information for your product. Some of these notices may not apply to your product.

Prohibition of co-location

This device and its antenna(s) must not be co-located or operated in conjunction with any other antenna or transmitter.

WEEE Notice

Disposal of Waste Electrical and Electronic Equipment and/or Battery by users in private households in the European Union



WEEE



Battery

This symbol on the product or on the packaging indicates that this cannot be disposed of as a household waste. You must dispose of your waste equipment and/or battery by handing it over to the applicable take-back scheme for the recycling of electrical and electronic equipment and/or battery. For more information about recycling of this equipment and/or battery, please contact your city office, the shop where you purchased the equipment or your household waste disposal service. The recycling of materials will help to conserve natural resources and ensure that it is recycled in a manner that protects human health and environment.

CE Regulatory Notice

The product herewith complies with the requirements of IEC62368-1:2018, the RED-Directive 2014/53/EU and the RoHS Directive 2011/65/EU.

EU Health Protection: This equipment should be installed and operated with minimum distance 20cm between the radiator & your body.

Notes on Installation

1. Please measure the front windshield viewing area, make sure not to block driver's front view, install the camcorder below the rearview mirror (the central, higher right position of the front windshield). And we recommend that the sky and the land occupied by the screen 50%, fix the car holder and then adjust the camcorder so that the lane is aligned with the screen. Proper installation enables the camcorder to maximize the efficiency also can enhance the accuracy of LDWS.
2. Make sure that the lens is within the wiping range of the windscreen wiper to ensure a clear view even when it rains.
3. Do not touch the lens with your fingers. Finger grease may be left on the lens and will result in unclear videos or pictures. Clean the lens on a regular basis.
4. Do not install the camcorder on a tinted window. Doing so may damage the tint film.
5. Make sure that the installation position is not hindered by the tinted window.
6. This product is suitable for light windshield or light color heat-resistant film windows, it will affect video quality if install it on the dark windows or dark heat-resistant film windows.
7. Use the products of the attached power charger only, please do not use other brand power charger, in order to avoid equipment burn or cause the battery explosion.

Caution

- ❖ Disposal of a battery into fire or a hot oven, or mechanically crushing or cutting of a battery, that can result in an explosion.
- ❖ Leaving a battery in an extremely high temperature surrounding environment that can result in an explosion or the leakage of flammable liquid or gas.
- ❖ Due to local laws and vehicles safety considerations, do not operate the camcorder while driving.
- ❖ Set up time zone, time and date accurately before you use this camcorder.
- ❖ The firmware function in the camcorder is for reference only, drivers are advised to exercise discretion based on actual road conditions.

- ❖ The results of GPS positioning are only for reference, and should not affect the actual driving situation. The camcorder also cannot ensure the positioning accuracy.
- ❖ GPS positioning accuracy may differ depending on weather and location such as high buildings, tunnels, undergrounds, or forests. GPS satellite signals cannot pass through solid materials (except glass). Tinted window will also affect the performance of the GPS satellite reception.
- ❖ GPS reception performance on each camcorder may differ. The camcorder cannot determine the accuracy of the positioning results from different hardware.
- ❖ The values displayed in this camcorder, such as speed and position, may be inaccurate due to the influence of surrounding environment. They are for your reference only.
- ❖ This product is used only for non-commercial use, within the maximum limits permitted by applicable law. We do not take any responsibilities for the loss of use of the product.
- ❖ This camcorder gets warm when in use; this is normal.
- ❖ Improper use or operation of the product may result in damage of the product or its accessories and void the warranty.
- ❖ Wi-Fi Signals are unable to pass through the building. The upper limit of signal transmission is 5m.
- ❖ Wi-Fi Operation Channel: Ch1~Ch11
- ❖ The product employs wireless data communication which may interfere, or be interfered by, a near-by camcorder.
- ❖ Never use this camcorder in the vicinity of a microwave oven or at places where there is radio interference.
- ❖ Radio wave reception may be worsened in specific environments.
- ❖ Please be advised that if another camcorder is also using the same 2.4GHz band as this product, the processing speed of both camcorders may slow down.
- ❖ This product gets warm when in use; this is normal.
- ❖ Improper use or operation of the product may result in damage of the product or its accessories and void the warranty.
- ❖ The radio frequency (RF) generated by this RF electronic camcorder may cause adverse effects on the operation of other electronic camcorders and result in malfunctioning. Wireless transmitters and circuitry may also interfere with other electronic camcorders. Therefore, do observe the following precautions:

- **Aircraft:** Never use a radio transmitter when you are in an airplane. Please switch off the Wi-Fi function of the camcorder.
 - **Vehicle:** The radio frequency transmitted by this camcorder may affect the electronic system in a motorized vehicle. Please consult the manufacturer or dealer of your vehicle on the possible effect.
 - **Pacemaker:** In order to prevent any potential interference to a pacemaker, anyone who uses a pacemaker should be advised, that, when using this camcorder, a minimum distance of 15cm (6 inch) should be kept between the camcorder and the pacemaker; and never put this camcorder in a chest pocket. In case of any doubt of interference, switch off the camcorder immediately.
 - **Medical Camcorder:** If you use a personal medical camcorder, consult the camcorder manufacturer or your physician to confirm if your camcorder is sufficiently shielded from the RF transmission of this camcorder.
 - **Medical Facilities:** Hospitals and medical institutes may use facilities that are sensitive to an external RF energy. Observe such instructions when the medical care personnel or any posted sign requests you to switch off any camcorder that may interfere the radio frequency.
 - **Explosion sites or any location with a posted sign:** In order to prevent interfering with an explosion activity, observe all the signage and instructions in the Explosion Area or in a zone with a “Switch Off 2-way Radios” sign by switching off camcorders that may interfere with the radio frequency.
- ❖ HP Inc. is NOT responsible for the loss of any data/content during operation.

Before you start using the system, it is assumed that you agree to the above statement.

1 Introduction







Thank you for purchasing this advanced Car Camcorder. This product is specifically designed for real time video recording when driving.

1.1 Features

- 2MP CMOS sensor
- Full HD 1920*1080
- 3.0" TFT-LCD color screen
- 120° Wide angle lens
- Collision Detection, when a collision is detected, the camcorder will automatically trigger the emergency recording
- Parking Mode
- Multifunction traffic safety reminder
- Built-in GPS and Wi-Fi
- Optional 1080p rear camera

1.2 Package Contents

The package contains the following items. In case there is any missing or damaged item, contact your dealer immediately.

Car camcorder	Electrostatic Sticker	Bracket
		
Quick start guide	Car charger	Rear Camera (option)
		

1.3 Product Overview

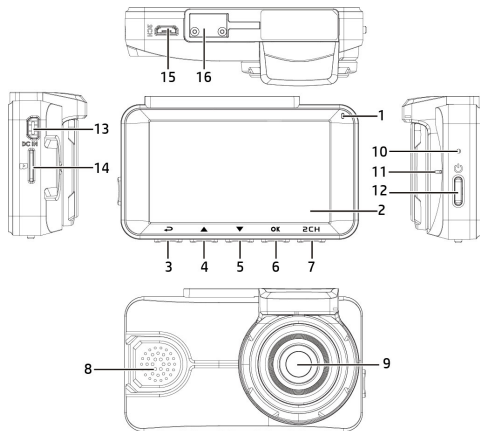

No.	Item	No.	Item
1	LED Indicator	8	Speaker
2	LCD Color Screen	9	Wide Angle Lens
3	Menu / Back Button (☰ / ↶)	10	Reset
4	Add Speed Point / Up Button (⏏ / ▲)	11	Microphone
5	Snapshot / Down Button (📷 / ▼)	12	Power/HUD
6	Emergency Recording / Confirm Button (⚠ / Ⓞ)	13	Power Connector Port
7	Switch Camera Button (📷 / ZCH)	14	Memory Card Slot
		15	Rear camera connector port (option)
		16	Bracket Socket

Note:

Please press the button (3~7) according to the diagram notice shown on screen.

2 Getting Started

2.1 Storage Media

2.1.1 Insert the Memory Card

Insert memory card with the pins facing forward, see the picture as below:

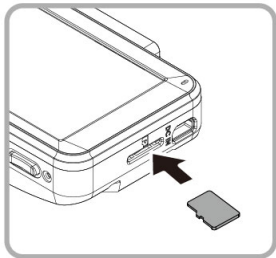

2.1.2 Remove the Memory Card

If the camcorder is power on, please power off first and wait for the procedure of switching off the camcorder completed before removing the memory card.

Note:

1. Do not remove or insert the memory card when the camcorder is turned on. This may damage the memory card.
2. Suggest to use class V30 or higher, and capacity 16GB or higher micro SD card.
3. Please format the micro SD cards before the initial use. The formatted file type for this camcorder is FAT32 file.
4. Periodically format the microSD card (recommended period: once a month).
5. Capacity of 64GB or higher must format by the device before starting to use.
6. Memory cards have a service life. Long-term use may lead to write speed degradation and file save failure. If this happens, it is recommended that you purchase a new memory card.
7. Due to the various specifications of memory cards on the market, and the quality is uneven, we do not guarantee that all memory cards are compatible with our products. If there is a memory card abnormality, resulting in the inability to store recorded images, It's not directly related with the dashcam. Please swap the new card from where you purchased.

2.2 Installing in Vehicles

1. Put the electrostatic sticker onto the suggested area on the windshield. Before putting the sticker, please wipe and clean the windshield. During the installation, please make sure the bubbles in between the sticker and the window are all gone.

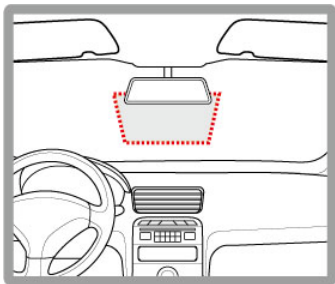

2. Push the mount into mount slot on top of device, until a click sound is heard.

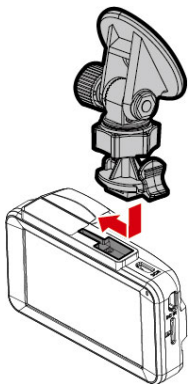

3. Peel off the protective plastic sheet from the adhesive bracket.

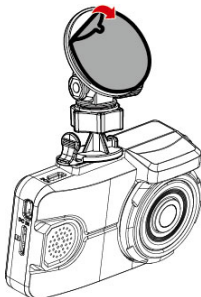

4. Place and press the bracket firmly onto the electrostatic sticker on the windshield window. Make sure the base is securely locked in place.

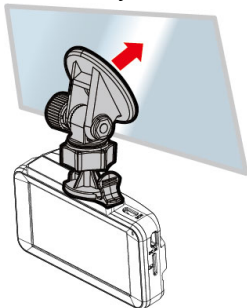

5. Loosen the knob to swivel the device vertically or horizontally.

6. Then tighten the knob to make sure the device is securely locked in place.

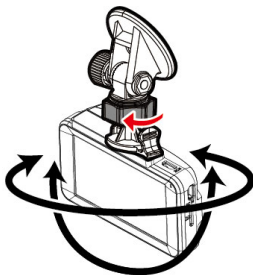

2.3 Connecting to Power

Use only the supplied car charger to power up the camcorder.

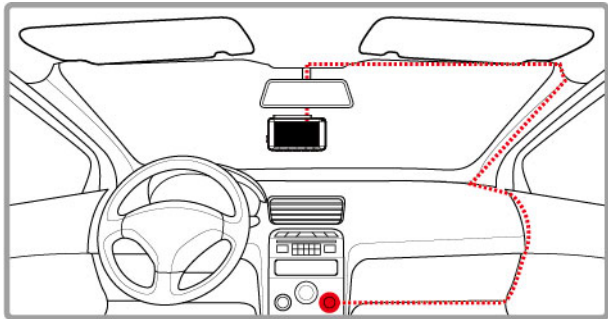

1. Connect one end of the car charger to the USB connector of the camcorder. USB port input: DC 5V / 1.5A.
2. Plug the other end of the car charger to the cigarette lighter socket of your vehicle. Once the vehicle engine is started, the camcorder automatically powers on. Car charger input: DC 12 / 24V.

2.4 LED Indicator

Status Explanation	LED Indicator Color
Standby (not recording)	Green LED: always on
Recording/ Recording and screen off	Red LED: flash

2.5 Powering the Camcorder On / Off

2.5.1 Auto Power On/Off

Start the car engine, wait a few seconds to charge the camcorder, and then screen will light up and the camcorder will automatically power on and start recording.

Once the vehicle engine shuts down, the camcorder automatically saves the recording and turns off the power.

Note:

The camcorder is built-in super capacitor. After start the car engine, please wait a few seconds for charging the camcorder, and then the camcorder will automatically power on and start recording.

2.5.2 Manual Power On/Off

To manually turn on the power, press the **POWER** button.

To turn off, press and hold the **POWER** button for at least 2 seconds.

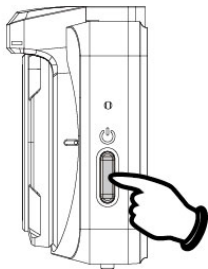

2.5.3 Reset

Use a pin or paper clip to insert and hold the Reset hole for 5 seconds to reset the device.

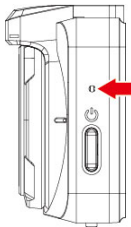

2.6 Initial Settings









Before using the camcorder, we recommend you setup the correct **Time zone, Date and Time**.

Note:

Please note that if you press the  button during recording, the system will stop recording and enter OSD menu. Make sure the recording is already stopped then continue operating the menu.

2.6.1 Set Time Zone

To set the time zone, do the following:







1. Press the  button to enter the OSD menu.
2. Press the  or  button to select **Set Time Zone**, and then press the  button for entering function menu.
3. Press the  or  button to set the current time zone, and then press the  button to complete setting.
4. Press the  button to return to recording screen.

Note:

If satellite positioning is not successful, camcorder clock will run based on user defined time.

2.6.2 Set the Date / Time

To set the correct date and time, do the following:

1. Press the  button to enter the OSD menu.
2. Press the  or  button to select Date / Time, and then press the  button for entering function menu.
3. Press the  or  button to adjust the value, and then press the  button to set the next field.
4. Repeat step 3 until the date and time setting is completed.

Note:

To ensure the accuracy of the video file time, please reset the date and time when the battery power runs out or when not in use over 7 days.

3 Using the Car Camcorder

3.1 Automatic Record

Once start the car engine, the camcorder will automatically power on and start recording.

















Recording will automatically stop when the engine is switched off.









Note:

1. Some vehicle power supply would not turn on / off automatically with the car engine start, if the camcorder cannot automatically power on/off with the car engine, please manually connect the power supply with the vehicle power, and then power on, or manually power off the camcorder and then release the connector with the car power supply.
2. It can be configured to save a video file for every 1 or 3 minutes of recording.
3. All the videos and photos are saved in the memory card, if memory card is full, loop recording will generally overwrite the oldest video file.
4. The camcorder is built-in super capacitor. After start the car engine, please wait a few seconds for charging the camcorder, and then the camcorder will automatically power on and start recording.

3.1.1 The Recording Screen



No.	Icon	Item	Description
1		Recording Duration	Indicates the video current duration.
2		Car Speed	Current car speed
3		Date / Time	Indicates the current recording date and time.
4		Menu Button	During video recording, press the  button to enter the OSD menu.
5		Add Speed Point Button	During video recording, press the  button to add a speed cam point.
6		PIV (Picture in Video) Button	Press  to capture video screen shots from the front camera.
7		Emergency Recording Button	During video recording, press the  button to enter emergency recording mode.
8		Switch Camera Button	Press  to switch VIV screen. (Rear Camera is not included in standard package. Please contact distributor for further information.)
9		Satellite Positioning icon	Indicates the strength of satellite positioning. If the icon shows in red on screen, it indicates that the camcorder cannot complete the satellite positioning.
10		Voice Record icon	Indicates voice recording sets as off, the sound will not be recorded.
11		Resolution icon	Indicates the video resolution.

12		<p>microSD Card icon</p>	 Card is inserted.  No card.
13		<p>Power icon</p>	<p>The device is connected with the power.</p>
14		<p>Wi-Fi</p>	 Wi-Fi on  Wi-Fi off
15		<p>VIV (Video in Video)</p>	<p>Indicates rear camera recording screen. (Rear Camera is not included in standard package. Please contact distributor for further information.)</p>

3.1.2 Emergency Recording

To Start the Emergency Recording, do the following:

1. During Video Recording, press the  button to enter emergency recording mode, the “**Emergency**” message will be shown immediately on the upper left corner of the screen, and the recorded file will be protected.
2. The emergency video recording length is same as the recording interval setting. When the emergency recording length reaches the setting, the system will return to the general recording mode.



Note:

If the *Collision Detection* function is enabled and a collision is detected, the camcorder will automatically trigger the emergency recording. The emergency file is created as a new file and save in Event folder, which will be protected to avoid being overwritten by normal loop recording. The emergency video folder will occupy 20% of available memory card capacity. When the emergency video folder is full, the oldest emergency file will be automatically deleted by the newest emergency file.

3.2 Add Speed Point

You may customize speed cam positions in this product.



1. When the GPS positioning is completed , press  to update speed camera points.
2. This product features a capacity of 50 speed cam positions. In case you are trying to add more than that the system prompts with message “**Speed Position is full**”.

Note:

You may delete custom speed cam positions by selecting the *Delete Last Position* or *Delete All Position* option from the *Speed Position Management* menu. Please note that all of your existing speed cam positions are deleted once the *Delete All Position* option is selected. Make sure you are ready to recreate your custom speed cam positions before running this option.

3.3 Picture in Video

You can also use this camcorder to take snapshots of the current scene.

1. In recording status, press  to capture recording screen shots from the front lens.
2. When the icon  shows in the central of screen, it means the screenshots is completed.

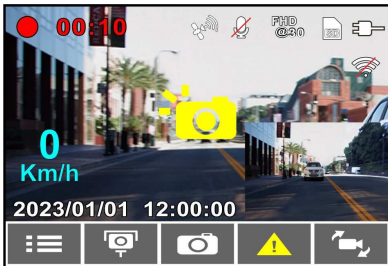

Note:

1. The screen shots image resolution quality is depending on the video resolution setting.
2. The picture resolution is limited by the speed of the target object and changes in ambient lighting. The photograph function is better used for taking still pictures in accident scenes or when the car is stopped to wait for a traffic light.

3.4 Driving Safety

The following driving safety function is for reference only. Drivers are advised to exercise discretion based on actual road conditions.







Note:

1. The *Driving Safety* function is limited to triggering no more than two alarms at the same time. If a voice and alert message have been triggered, any other alarm will be ignored until either of the two is settled.
2. Satellite positioning must be completed before functions such as *Speed Cam Alert*, *Speed Position Management*, *Speed Limit Alert*, *LDWS* and *FCWS* to be enabled. Be sure to check that Satellite positioning has been completed prior to using the product.
3. The detections of *LDWS* and *FCWS* may be inaccurate when used in rain, at night or in environments of insufficient lighting. Drivers are advised to exercise discretion based on actual road conditions.

3.4.1 Speed Cam Alert

If the **Speed Cam Alert** function is enabled, once your car's location is determined by GPS and approaches a speed cam, this product produces audible alert and screen message.

To enable the Speed Cam Alert, do the following:

1. Press the  button to enter the OSD menu.
2. Press the  button to select **Speed Cam Alert**, and then press the  button for entering function menu.
3. Press the  button to select **On**, and then press the  button to enable the function.
4. Press the  button to return recording screen.
5. The alarm screen turns red to remind you to slow down if you are driving faster than the speed limit.









Note:

The speed cam alert function must have the speed cam datum from the country you use. The function will be void if the product is used in any other countries. Please consult with the shop you purchased if the function is void. There is no guarantee the speed cam datum will be included for the worldwide countries.

3.4.2 Speed Limit Alert

If the **Speed Limit Alert** function is enabled, this product produces audible alert and screen message once your car's location is determined by GPS and its running speed exceeds the set limit.

To set the Speed Limit Alert, do the following:







1. Press the  button to enter the OSD menu.
2. Press the  button to select **Speed Limit Alert**, and then press the  button for entering function menu.
3. Press the  button to set up a Speed Limit Alert to trigger this product's alarm [Off / 50 ~ 200 km/h (30~125 mph)], and then press the  button to complete setting.
4. Press the  button to return recording screen.
5. The alarm screen turns red to remind you to slow down if you are driving faster than the speed limit.
- 6.



3.4.3 Driver Fatigue Alert

If the **Driver Fatigue Alert** function is enabled, this product produces audible alert and screen message one hour after it has begun recording and repeats the alerts every half hour afterwards.

To enable the Driver Fatigue Alert, do the following:







1. Press the  button to enter the OSD menu.
2. Press the  button to select **Driver Fatigue Alert**, and then press the  button for entering function menu.
3. Press the  button to select **On**, and then press the  button to enable the function.
4. Press the  button return to recording screen.
5. This product produces audible alert and screen message when **Driver Fatigue Alert** activates.



3.4.4 LDWS

Once your car's location is determined by GPS and the **LDWS** function is enabled, this camcorder produces audible alert and screen message when you drive off of or change lanes at speeds over 70 km/h (43 mph).

To set the LDWS (Lane Departure Warning Systems), do the following:

1. Press the  button to enter the OSD menu.
2. Press the  button to select **LDWS**, and then press the  button for entering function menu.
3. Press the  button to select **On**, and then press the  button to enable the function.
4. Press the  button to return to recording screen.

5. After enabling **LDWS**, the screen will display traffic lane align icon , please adjust the camcorder so that the horizontal line and the eye level are overlapped and the slash lines are centered in the driving lane.

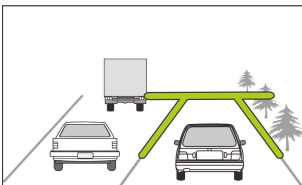

6. This product produces audible alert and screen message when **LDWS** is activates.









Note:

1. Please measure front windshield viewing area, do not block the driver's forward field of vision, and install the camcorder below rearview mirror (upper central of the front windshield). We recommend that the sky and the ground occupied 50 % of the video screen, install the bracket then adjust the camcorder to make the lane is aligned to the lane alignment icon. Correct installation makes the camcorder to maximize the efficiency and improve the accuracy of LDWS.
2. Make sure that traffic lane align icon will not be obscured other things (e.g. hood). It may cause misjudgment if the endpoint is obscured.

3.4.5 FCWS

Once your car's location is determined by GPS and the **FCWS** function is enabled, this camcorder produces audible alert and screen message when you drive at speeds over 60 km/h (37 mph) and are less than 20 m away from the car in front of you. If the camcorder not completes the satellite positioning, and the leading vehicle distance below 20 meters, it will also produce a warning screen and beep reminder.

To set the FCWS (Forward Collision Warning System), do the following:







1. Press the  button to enter the OSD menu.
2. Press the  button to select **FCWS**, and then press the  button for entering function menu.
3. Press the  button to select **On**, and then press the  button to enable the function.
4. Press the  button to return recording screen.
5. This product produces audible alert and screen message when **FCWS** is activates.



3.4.6 Headlight Warning

The **Headlight Warning** function produces audible alert and screen message when it detects poor lighting conditions through the recording displays of this camcorder, including driving in rainy or cloudy weather, at night, and in basements, parking lots, and tunnels.

To enable the Headlight Warning, do the following:

1. Press the  button to enter the OSD menu.
2. Press the  button to select **Headlight Warning**, and then press the  button for entering function menu.
3. Press the  button to select **On**, and then press the  button to enable the function.
4. Press the  button to return recording screen.
5. This product produces audible alert and screen message when **Headlight Warning** activates.









3.5 Parking Mode

To monitor the vehicle when it is parked, you can activate **Park Recording**, or **Collision Detection**, or **Timelapse**.

Before you activate Parking Mode, we commend to install ACC cable through professional car service shop.

Follow the steps below to change the settings for Parking Mode:

1. Press the  button to enter the OSD menu.
2. Press the  button to select **Parking Mode**, and then press the  button for entering function menu.
3. Press the  button to configure Parking Mode (Park Recording / Collision Detection / Timelapse/ Off), and then press the  button to complete setting.
4. Press the  button to return recording screen.

Note: ACC cable is not included in the package. Please ask for more information from your distributor.

3.5.1 Park Recording

- In normal recording, press and hold **Power** key for 3 seconds, the screen will show message "**Press OK key to power off or enter Park Recording after 10 sec.**" Please wait for 10 seconds and the camcorder will enter Park Recording automatically. The camcorder will turn off the screen temporarily, but still in recording status. Once the collision or vibration is detected, it will automatically trigger emergency recording.
- To disable this function, press any key to wake up the screen and resume to normal loop recording.

Note:

1. The video file taken in this mode is same as normal loop recording mode. It will be saved in the "Video" folder. And the emergency file will be saved in the "Event" folder.
2. The file size is according to Record Interval setting.

3.5.2 Collision Detection

- In normal loop recording mode, press and hold **Power** key for 3 seconds, the screen will show message “**Press OK to power off or enter Collision Detection after 10 sec.**” Please wait for 10 seconds and the camcorder will enter Collision Detection automatically. The camcorder will turn off the screen temporarily, but still in standby detection status. When the camcorder detects any motion in front of lens or any vibration/collision, the video recording will be triggered and the event will be recorded.
- To disable this function, press any key to wake up the screen and resume to normal loop recording.

Note:

1. The video file taken in this mode will be saved in the “Event” folder.
2. The file size is according to Record Interval setting.

3.5.3 Timelapse







- In normal loop recording mode, press and hold **Power** key for 3 seconds, the screen will show message “**Press OK to power off or enter Timelapse after 10 sec.**” . Please wait for 10 seconds and the camcorder will enter Timelapse automatically. The camcorder will turn off the screen temporarily, but in timelapse recording status.
- To disable this function, press any key to wake up the screen and resume to normal loop recording.

Note:

1. The video file taken in this mode will be saved in the “Video” folder.
2. In this mode, the camcorder is continuously recording by one second one frame. For example, 30 minutes recording will be saved in one minute.
3. The file size is according to Record Interval setting.

3.6 Collision Detection



If the **Collision Detection** function is enabled, this camcorder begins emergency recording once it detects any collision. Sensitivity of the Collision Detection function is set to Normal by default, if user wants to change the settings of Collision Detection, do the following:

1. Press the  button to enter the OSD menu.
2. Press the  button to select **Collision Detection**, and then press the  button for entering function menu.
3. Press the  button to change the sensitivity of this camcorder's collision detection (High Sensitivity / Normal Sensitivity / Low Sensitivity / Off), and then press the  button for entering function menu.
4. Press the  button return to recording screen.

3.7 HUD

The HUD function can check car speed at the moment and date/time. The HUD mode won't disturb the recording, nor the speed cam alert. There are two ways to enter HUD mode.

1. Manually

In the preview screen, press  Power button to enter. Press again  Power button to exit and back to preview screen.

2. Automatically



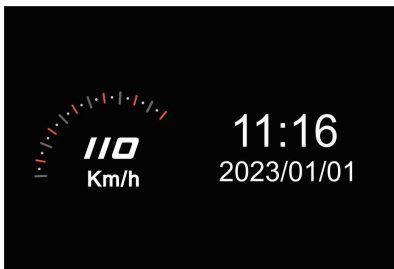





Turn on "HUD" function from "LCD Setting". Next time when the car starts, the camcorder starts up, about 7 seconds it will auto enter HUD mode if there is no operation on the camcorder. When HUD mode is on screen, anytime press  Power button to back preview screen. If there is no operation in 7 seconds, it will enter HUD mode again.



Note:

Driving Speed is only applicable when satellite positioning of the camcorder is ready; otherwise, they will be displayed in gray scale only.





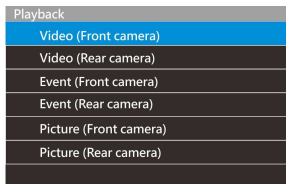



3.8 Playback Videos and Photos

1. If recording is in progress, press the  /  button to stop recording and enter the playback menu.
2. Press the  or  button to select the file category that you want to browse and press the  button to display thumbnail images of the recorded video or photo files.
3. Use the  or  to select the video or photo you want to playback, and press  button to confirm your selection.





3.9 Deleting Files

To delete file(s), perform the following steps:

1. Press the  button to stop recording and enter the main Menu.
2. Press the  or  button to select File Deletion and press the  button to confirm.
3. Press the  or  button to select folder and press the  button to confirm. Choose to delete one or delete all, and press the  button to confirm.

Item	Description
Delete One	Delete the current selected file.
Delete All	Deletes all files in this folder.

Use the  or  to select the video or photo you want to delete, and press  button to confirm your selection.

Note:

1. Deleted files CANNOT be recovered. Ensure the files you wish to preserve are backup before deletion.
2. If the file is taken by front camera and rear camera at the same time, no matter you delete video or picture from Front camera folder or Rear camera folder, both front camera file and rear camera file will be deleted.

4 Setting Go Moto Plus App

4.1 Download and Install

The camcorder allows you to connect to the smart phone via the app. When using for the first time, install the [Go Moto Plus] app for your smart phone.

1. Scan below QR code or download **Go Moto Plus** app from Google Play or App Store.
2. Install the app.



iOS/Android

APP layout and features may be changed subject to different software versions. Please refer to Google Play or APP Store for

4.2 Wi-Fi connection

1. Press the **Power** button to switch on the camcorder.
2. Enter Menu and go to **Wi-Fi** option; choose “ON” to activate the wireless network.
3. The camcorder’s screen will display Wi-Fi Device ID and Password. Using the Wi-Fi function of your smart phone, search for the camcorder ID “hp_f450x_xxxxxx” from the list (last 6 numbers are system random numbers). Enter default password **12345678**.



4. There is a Wi-Fi icon on the camcorder’s screen. Once the icon turns to blue, your connection has been successfully established.



Note:

1. The smart phone shall be within a maximum of a 5m distance from the camcorder without any buildings in between.
2. When the Wi-Fi function of the camcorder is ON but not yet connected with your smart phone, or the connection is disconnected, the Wi-Fi icon on camcorder's screen will be white.
3. When the Wi-Fi function of the camcorder is ON, and connected with your smart phone, if there is no operation from app within 3 minutes, the Wi-Fi will auto turn off. Get into Menu setting, and turn on "Wi-Fi" if you want to operate app.
4. After connecting the smart phone with the camcorder, and activate app feature "Network Streaming", all the button operation of the camcorder will be disable; all the operations shall be carried out via the Go Moto Plus App.
5. The language of the Go Moto Plus app will be consistent with your smart phone, beyond the language options, the app will be activated with default language.
6. Supports OS: Android 9.0 or higher, iOS 13 or higher, Harmony 2 or higher.









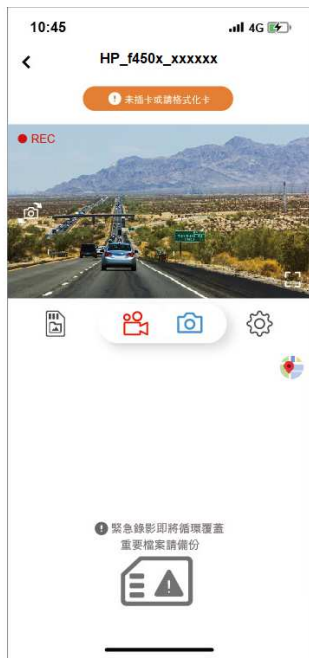
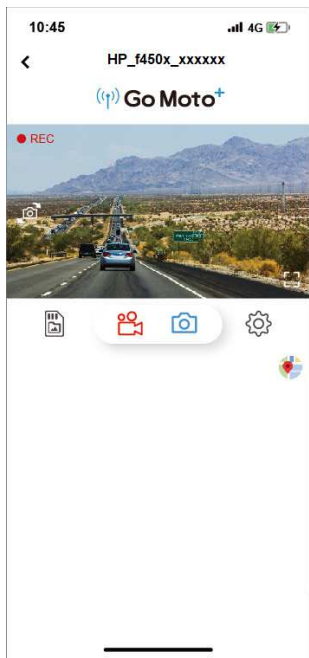

5 Using the Go Moto Plus App

Tap [Go Moto Plus]  icon to activate the app. The main screen will pop up. Follow the below instruction to operate this application.



5.1 Main Screen



icon	Description
	Go Moto Plus logo / memory card message
	Preview
	Switch front and rear camcorder preview
	Full screen display
	Start/Stop Record
	Snapshot
	Camera File. Recorded files in microSD card.
	Camera Setting
<p data-bbox="88 841 347 885">Emergency video files will be overwritten by loop recording Backup important files</p> 	Note: The emergency videos folder in microSD reaches capacity, and will be overwritten by new recordings. Please back up important files. This message icon will eliminate after backup.
	Map and driving track

Note:

1. The App will auto sync the camera's date/time with your smartphone.
2. App layout and features are subject to change, depending on the software version. Refer to the Google Play Store or iOS App Store for the latest updates.
3. Android phones please download Google Offline Maps in advance. Firstly, update Google Maps to the latest version, open the Google Maps app, click on the user account picture above, and click "Offline Area", select "Custom Area", select the area where you want to download the offline map, confirm and press "Download".

5.2 Playback, delete and download

You can use this feature to playback or delete the file saved in camcorder, or to download the file from camcorder to your smart phone.

1. Tap the icon  [Camera File].

2. The files saved in the camcorder will be displayed on your smart phone.

Camcorder will stop recording for a few seconds until your smart phone

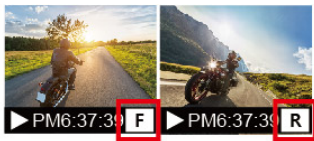

finishes reading the saved files from camcorder. There are three folders,

Loop, Snapshot and Locked. The “F” and “R” letter at the right bottom corner of preview thumbnail stands for “Front camera” and “Rear camera”. Tap the preview thumbnail to playback the file.

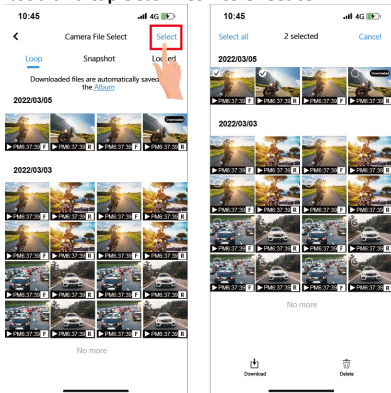

3. Tap the right top corner “Select” and pick up the files that you want to delete or download and tap below icon to execute.



Icon	Description
	Download the file to smartphone.
	Delete file from microSD card.
	Downloaded file will mark as “Downloaded” on preview thumbnail. It can be opened from “Album” without Wi-Fi connection to the camera.

Note:

1. If recordings have no audio, check if Microphone is OFF in the menu. For video playback, we recommend VLC Media Player.
2. Deleted files cannot be recovered. Backup any important files before deleting them.
3. The snapshot is activated by app. The image file will be stored both in microSD card in the camera and “Album” folder of MUFU Video app. The file will be marked as “Downloaded” on preview thumbnail.
4. If you plan to download a large number of videos and photos, take out the microSD card and use PC/Mac.

5.3 Local Album



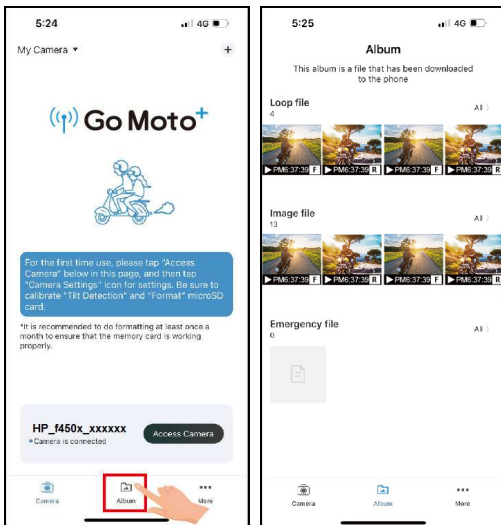

You can use this feature to playback or delete the file that you download in your smart phone. The file can be opened and reviewed without Wi-Fi connection to the camera.

1. Tap the icon  [Album] below the home page. The camera will stop recording if it's connected with app.

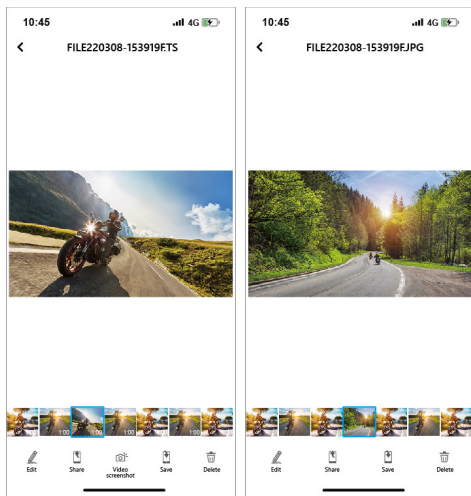

2. Tap the file from preview thumbnail to playback, delete or edit.



Icon	Description
	Edit the video or photo. (refer to next step for details.)
	Share the video or photo to social media.
	Video screenshot.
	Save the video or photo to smartphone's album. When the file is saved, the screen will show a message of "Save to smartphone's album successfully." and smartphone's album will automatically create a folder named "Go Moto Plus".
	Delete the downloaded file in App's Album. The file in the microSD card in the camera is still existed.

5.3.1 Edit Video or Picture

Open the downloaded file in “Album”, then, tap  Edit icon. The video or picture can be edited.

1. Edit video: Remove original audio/voice, and embed favorite music from the recommendations.

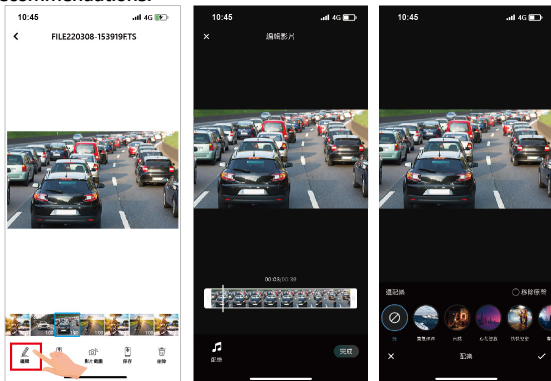

2. Edit picture: Crop the picture, or change the color of picture from recommendations.

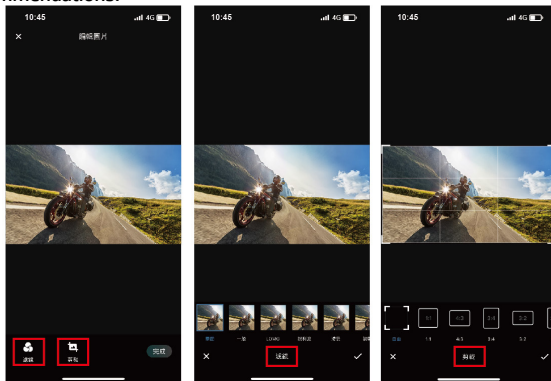

5.4 Camera Setting

You can use this feature to set up your car camcorder by app.



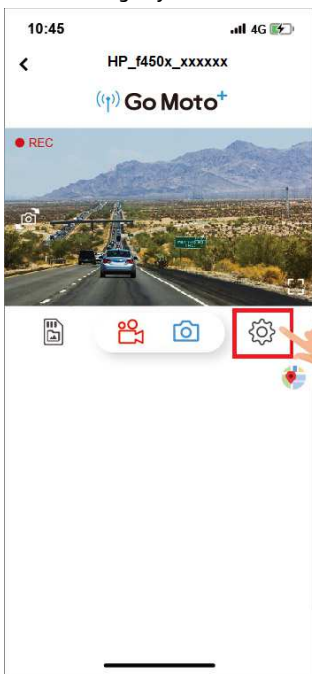



1. Tap icon  [Camera Setting]. The camcorder will stop recording.
2. Set up the options according to your favorite or needs.



6 Adjusting the Settings

6.1 Using the Menu

You can customize the general settings via the on-screen display (OSD) menus.

1. Press the  button to enter the OSD menu.
2. Press the  button to select menu item, and then press the  button for entering function menu.
3. Press the  button to select or adjust the value, and then press the  button to confirm setting.
4. Press the  button to return recording screen.

6.2 Menu Items

Refer to the below table for details of main menu and function list.

Menu option	Description	Available option
Playback	Select the file category that you want to view.	Video (Front camera) Video (Rear camera) Event (Front camera) Event (Rear camera) Picture (Front camera) Picture (Rear camera)
Satellite Status	Displays the current state of the satellite reception.	
Wi-Fi	Turn on Wi-Fi to connect with smart phone.	On / Off
Speed Unit	The system displays the speed setting unit.	KM/H / MPH
Car Speed Watermark	To turn on or off car speed watermark.	On / Off
Time Stamp	To turn on or off file stamp including model number, date/time, car speed and location info.	On / Off

Menu option	Description	Available option
Speed Cam Alert	If the Speed Cam Alert function is enabled, once your car's location is determined by GPS and approaches a speed cam, this product produces audible alert and screen message.	On / Off
Speed Position Management	Delete Last Position: Delete the last speed camera point. Delete All Position: Delete all speed camera point.	Delete Last Position / Delete All Position
Speed Limit Alert	Set a customized maximum speed limit. When the vehicle speed exceeds the maximum, an audible alert is automatically triggered and a warning message is displayed on the screen.	Press the \triangle/∇ button to set the speed limit. You can set the off, or set speed limit from 50 to 200km/h (30 to 125mph)
GPS Broadcast	Turn on or off speed cam alert voice reminder.	On / Off
Set Time Zone	Set the time zone you are in.	GMT -12 ~ GMT +12
Date / Time	Set the date and time.	Press the \triangle/∇ button to adjust the value, and then press the \odot button to set the next field, and complete setting
Language	Language setting.	According to the actual shipping regions.
Resolution	Setting of video resolution.	1920x1080 30fps 1280x720 30fps
EV	Setting of exposure value.	-2 ~ +2
LCD Setting	Set LCD off time or HUD. Set HUD: After power on 7 seconds, the screen will be always in HUD mode. Press  button can exit HUD mode and return to preview scree. (Recording is not affected when screen is in HUD mode).	On/ Turn off after 7 sec / Turn off after 1min / HUD

Menu option	Description	Available option
	Set off after 7sec or 1min: Screen will be off after a set time if no operation is detected during the standby or record mode. Press any button will switch it on. (Recording is not affected when screen is off).	
Voice Record	Setting for activating audio in the video.	On / Off
Key Tone	Enable / disable power-on sound and key tone.	On / Off
Volume	Adjust the sound volume.	0 ~ 10.
Record Interval	Save respective video files in a length of the selected duration.	1 min. / 3 min.
Parking Mode	If one of parking mode is activated, the camcorder will enter parking mode 10 seconds after disconnect the external power. *Require to install ACC cable.	Park Recording / Collision Detection / Timelapse / Off
Collision Detection	If Collision Detection is activated, this camcorder starts emergency recording once it detects any collision.	High Sensitivity / Normal Sensitivity / Low Sensitivity / Off
Driver Fatigue Alert	When Driver Fatigue Alert is enabled, audible alert and screen message will be activated 1 hour after the camcorder is powered on, with a repetition every 30 minutes.	On / Off
LDWS	Once your car's location is determined by GPS and the LDWS function is enabled, this camcorder produces audible alert and screen message when you drive off of or change lanes at speeds over 70 km/h (43 mph).	On / Off

Menu option	Description	Available option
FCWS	When FCWS is activated after satellite positioning, camcorder will issue audible alert and screen message when vehicle speed is above 60 km/h (37 mph) and the distance with the front vehicle is less than 20m.	On / Off
Headlight Warning	When Headlight Warning is activated, camcorder will issue an audible alert and screen message reminding that insufficient brightness is sensed on the recording face.	On / Off
File Deletion	Delete the file(s).	Video (Front camera) Video (Rear camera) Event (Front camera) Event (Rear camera) Picture (Front camera) Picture (Rear camera)
Anti-flicker	Domestic power supply varies by area. It is recommended that you should check the "Table of voltage and frequency of different countries" for the correct setting.	60Hz / 50Hz
Format	Format the memory card inserted in the equipment. All the files in the card will be erased.	Yes / No
Default	The system reverts to the default setting.	Yes / No
Firmware Version	Indicates the current firmware version.	

7 Specifications

Item	Description
Image sensor	2MP CMOS sensor
Effective pixels	1920 (H) x 1080 (V)
Storage media	Supports microSD card with class V30 or higher, and capacity 32GB or higher.
LCD display	3" LCD color TFT
Lens	Wide Angle Fixed Focus lens Aperture: Up to F1.8
Focus range	1.5m~Infinity
Satellite System	GPS
Video	Resolution: 1920x1080 30fps 1280x720 30fps
	Format: TS
Still image (Photograph)	Resolution: depends on video resolution setting
	Format: DCF (JPG)
Shutter	Electronic shutter
G-Sensor	3-Axis G-Force sensor
ISO	Auto
White Balance	Auto
Microphone	Built-in
Speaker	Built-in
Interface	Mini USB, micro USB
Power	Super Capacitor

Item	Description
Operating Temperature	0° ~ 45° C
Operating Humidity	20 ~ 70% RH
Storage Temperature	-20° ~ 70° C
Dimensions	86.5 x 52 x 28.5 mm
Weight	Approx. 90g

Built-in IEEE 802.11g/n(HT20) Wi-Fi chip: RTL8188FTV

Frequency range	2412~2462MHz
Wi-Fi Channel	Ch1~Ch11